

Data Sheet



Article number: 586350212

Description: Ball Valve 350.212, G 1" - G 1"
Thread/Thread

Measures

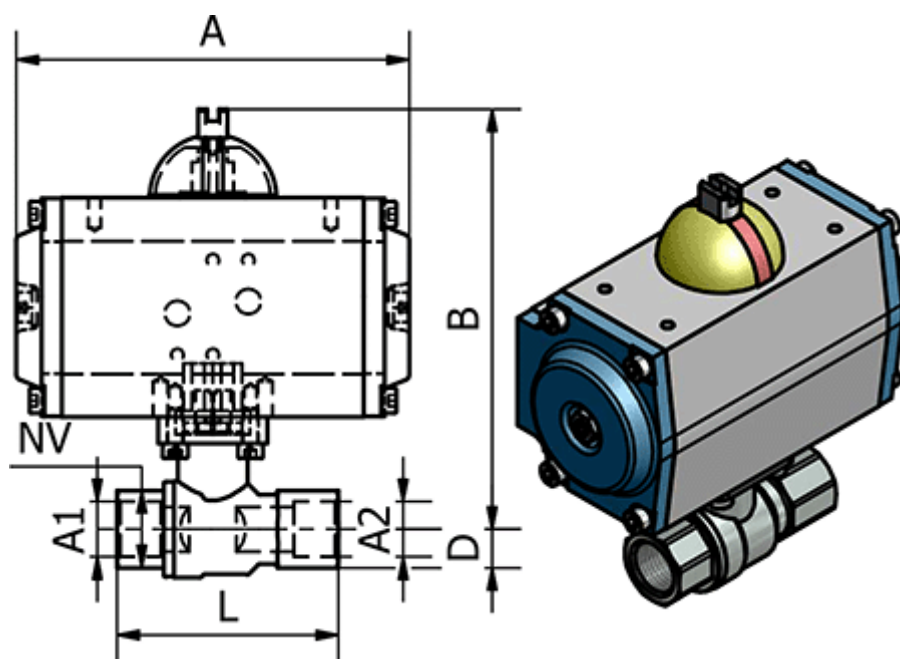

A	= 133
B	= 148
Connecting A1	= G 1"
Connecting A2	= G 1"
D	= 25
L	= 90
Max. Operating Pressure	= 40 bar
NV	= 41